

LU 1100-LEIVINUUNI

Peruskokoinen PT tiili	~206kpl
UT-tiili 257x85x57	~158kpl
MRT 60 kuorimuuraukseen	~250kpl
TTT tulitiili,257/123/57	~58 kpl
MTT tulitiili,257/85/57	~59kpl
Saviuunilaasti	~364 kg
Tulenkestävä valumassa	~270 kg
M100/600, kuorimuuraukseen	~225 kg
Tulenkestävä muurauslaasti ,tulitiilien muuraukseen	~29,25kg
TUL 10, tulisijalevy	~5,111m ²
PAL50, palonsuojalevy	1 levy
Leivinuuninluukku 410/230-180 taustalevyllä	1
Tuhkapesän luukku270/130, muurausholkkeineen	2
Nuohous 130/130, holkkeineen	2
Arinamurskaa ,murskattu lasi tai hiekka	40L
Häkäputki 60/60/3'pituus tapauskohtainen	1
Sulkumekanismi,teetettävä	1

Leivinuuni 1100 massaluettelotaulukko laskenta

KERROS	PT	UT	TULI123	TULI85	MRT60	SAVI	ML	VALUMASSA				TULISIJALEVY			BURTON	ARINALAATAT	arinamurska
								PITUUS	LEVEYS	KORKEUS	M3	PITUUS	KORKEUS	M2-MÄÄRÄ			
1	32				12	32	12					4.367	0.07	0.30569			
2	19				12	19	12					4.367	0.07	0.30569			
3	20				12	20	12					4.367	0.07	0.30569			
4	18				12	18	12					4.367	0.07	0.30569	800/123/60		
5	17	7			10	22.6	10	0.683	0.394	0.06	0.016146	4.367	0.07	0.30569			
6	25		1	3	12	25	12					4.367	0.07	0.30569			
7	20		5		12	20	12					4.367	0.07	0.30569			
8	20		5		12	20	12					4.367	0.07	0.30569			
9	24		0		12	24	12					4.367	0.07	0.30569			
10	29		0		12	29	12					4.367	0.07	0.30569			
11	29		0		12	29	12					4.367	0.07	0.30569			
12	25	5	0		24	29	24					4.367	0.07	0.30569			
13	21	3	1		11	23.4	11					4.367	0.07	0.30569			
14	12		9	2	11	12	11					5.307	0.07	0.37149	250/250*6		
15	12	0	9	0	11	12	11					5.307	0.07	0.37149			26L kuivaa
16	12		10		11	12	11					5.307	0.07	0.37149			
17	12	0	9		11	12	11				0	5.307	0.07	0.37149			
18	0	0	17	0	12	0	12	0.72	0.8	0.12	0.06912	5.307	0.07	0.37149			
19	0	0	16	0	12	0	12				0	5.307	0.07	0.37149			
20	0		15		12	0	12	0.82	0.125	0.06	0.00615	5.307	0.07	0.37149			
21	0	0	16	0	12	0	12				0	5.307	0.07	0.37149			
22	0	0	30	0	12	0	12				0	5.307	0.07	0.37149			
22.5			0		0	0	0				0			0			
23			0		12	0	12	1.07	1.07	0.06	0.068694	5.307	0.07	0.37149			
24	0	0	0		12	0	12				0	5.307	0.07	0.37149			
25	32	0	0	0	12	32	12				0	5.307	0.07	0.37149			
26	32	0	0	0	11	32	11				0	5.307	0.07	0.37149			
27																	
28																	
29																	
30																	
31																	
YHT	411		143	5	316	423	316				0.16011			8.80334			

Leivinuuni 1100 massaluettelotaulukko yhteenveto

KERROS	PT	UT	TTT	MITT	MRT	SAVI	MLS	TULI	syvyys	pituus	korkeus	M3	pituus	korkeus	pituus	korkeus
									VMASS				TUL10	PAL50		
1	24	0	0	0	11	24	9.9	0					0	2.7		
2	16	0	0	0	11	16	9.9	0					0	2.7		
3	16	0	0	0	11	16	9.9	0					0	2.7		
4	16	0	0	0	11	16	9.9	0					0	2.7		
5	8	0	0	0	11	8	9.9	0	0.8	0.7	0.06	0.0336	0	2.7		
6	10	0	7	0	9	10	8.1	1.75					0	3.5		
7	10	0	8	0	9	10	8.1	2					0	3.5		
8	10	0	7	0	9	10	8.1	1.75					0	3.5		
9	10	0	8	0	9	10	8.1	2					0	3.5		
10	10	0	7	0	9	10	8.1	1.75					0	3.5		
10.5	0	0	8	0	0	0	0	2								
11	10	0	10	0	9	10	8.1	2.5					0	3.5		
12	10	0	0	0	11	10	9.9	0	0.13	0.7	0.12	0.01092	0	3.5		
12.50	0	0	0	0	0	0	0	0						0		
13	10	0	9	0	11	10	9.9	2.25	0	0	0	0	0	3.5		
13.5	0	0	14	0	0	0	0	3.5	0	0	0	0	0	0		
14	10	0	16	0	11	10	9.9	4					0	3.5		
15	10	0	3	0	11	10	9.9	0.75					0	3.5		
16	9	0	4	0	11	9	9.9	1					0	3.5		
17	0	0	13	0	11	0	9.9	3.25					0	3.5		
18	0	0	13	0	11	0	9.9	3.25					0	3.5		
19	0	0	28	0	11	0	9.9	7					0	3.5		
20	0	0	0	0	11	0	9.9	0	1.1	0.9	0.06	0.0594	0	3.5		
21	24	0	0	0	11	24	9.9	0	0	0	0	0	0	3.5		
22	24	0	0	0	11	24	9.9	0					0	3.5		
23	0	0	0	0	0	0	0	0					0	0		
24	0	0	0	0	0	0	0	0					0	0		
25	0	0	0	0	0	0	0	0					0	0		
26	0	0	0	0	0	0	0	0	0.8	1	0.06	0.048	0	0		
27	0	0	0	0	0	0	0	0					0	0		
28	0	0	0	0	0	0	0	0					0	0		
29							0	0					0			
30							0	0					0			
YHT	237	0	155	0	230	237	207	38.75				0.15192	73	0.07		
													5.11			

LEIVINUUNI 1100

A-A

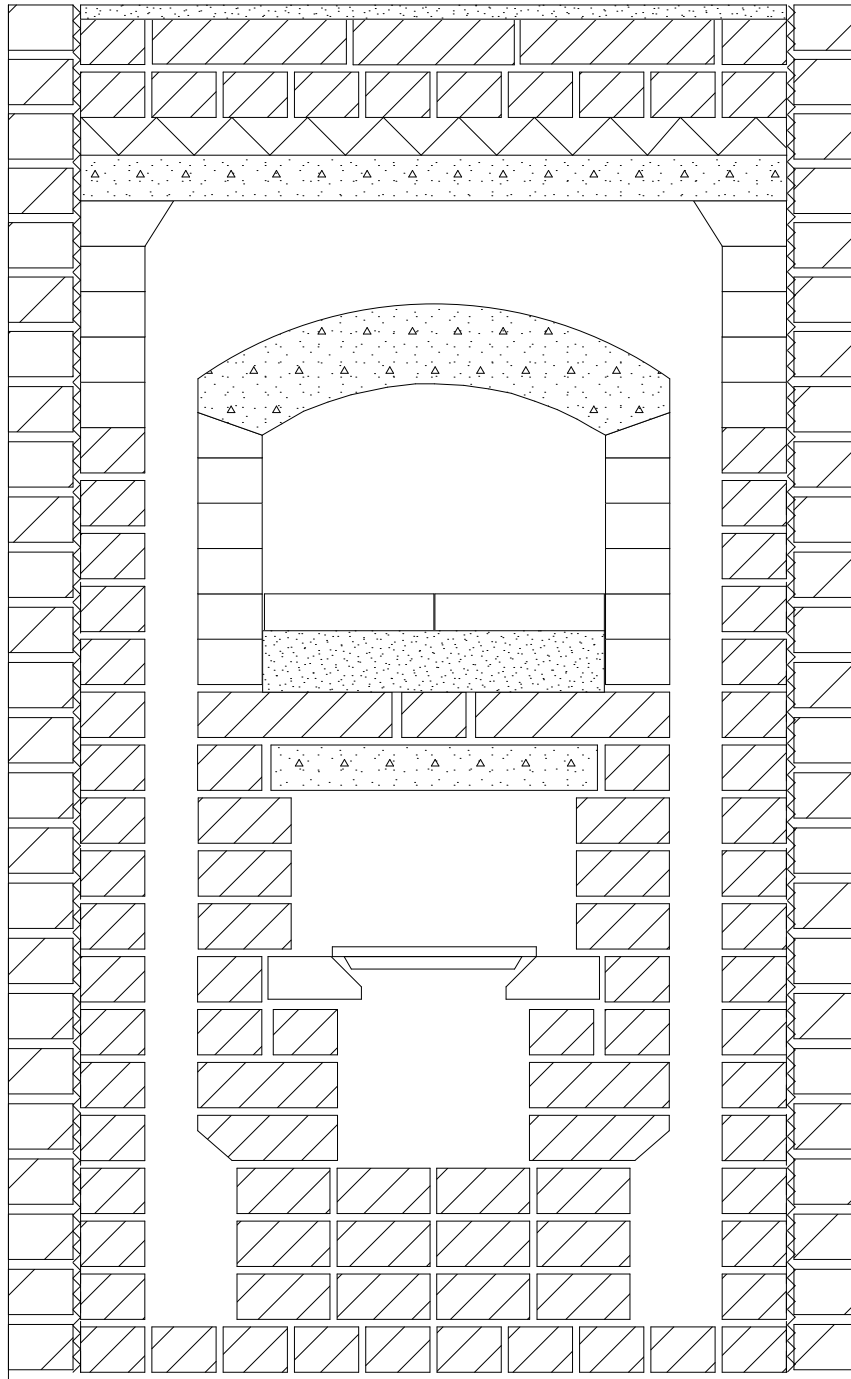

1 809

MK 1:10

LEIVINUUNI 1100

B-B

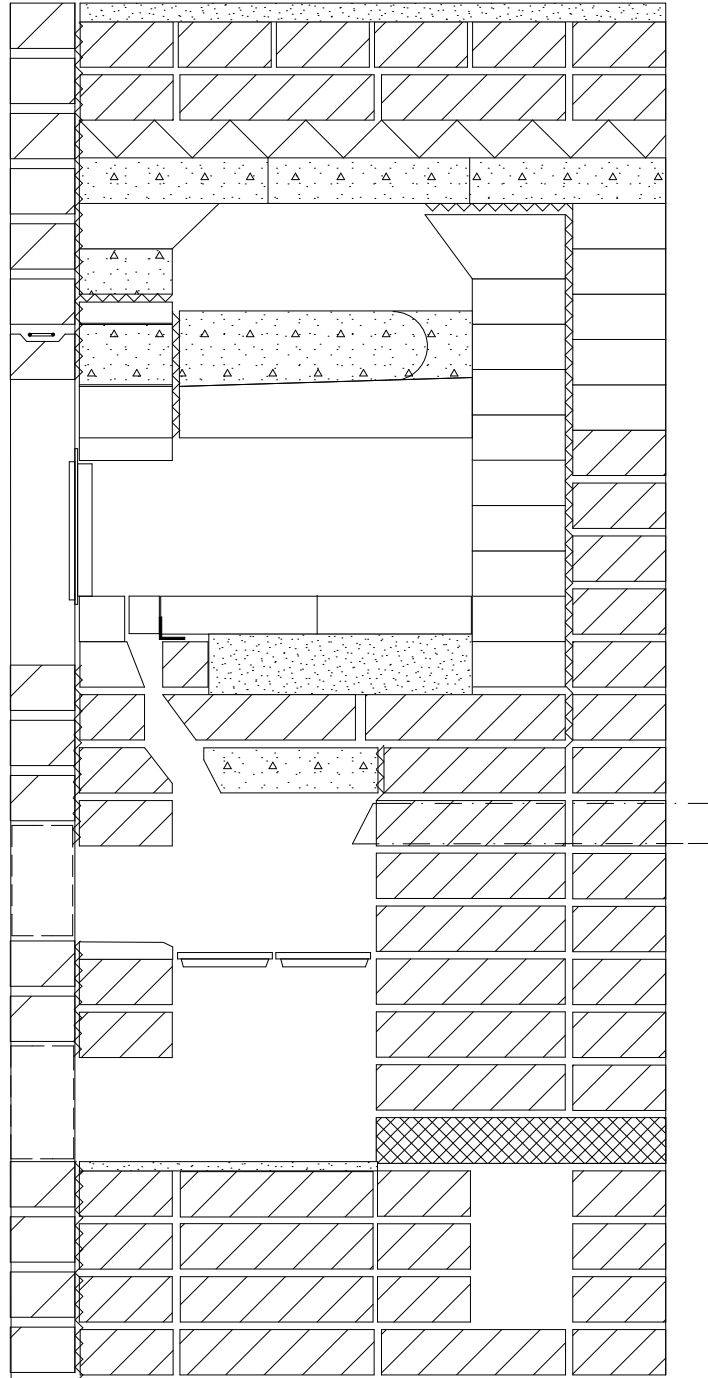

LEIVINUUNI 1100

edestä

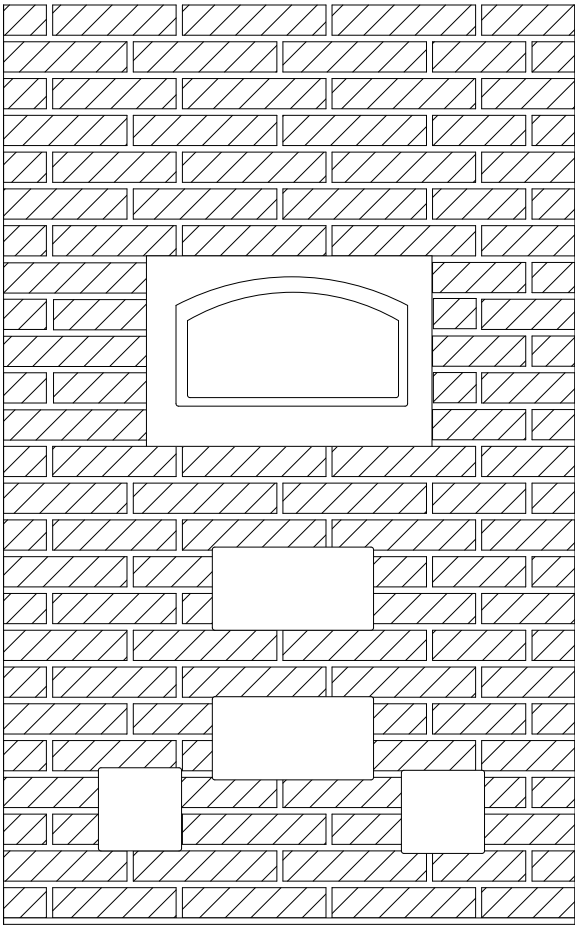

oikealta

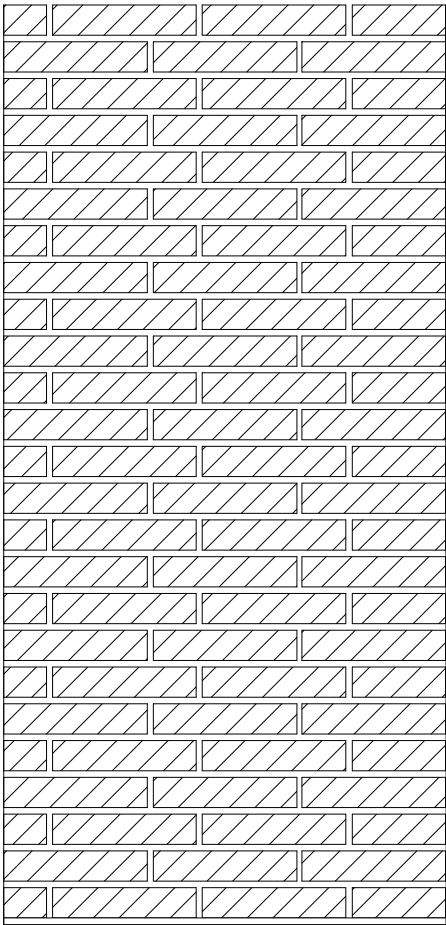

DET A

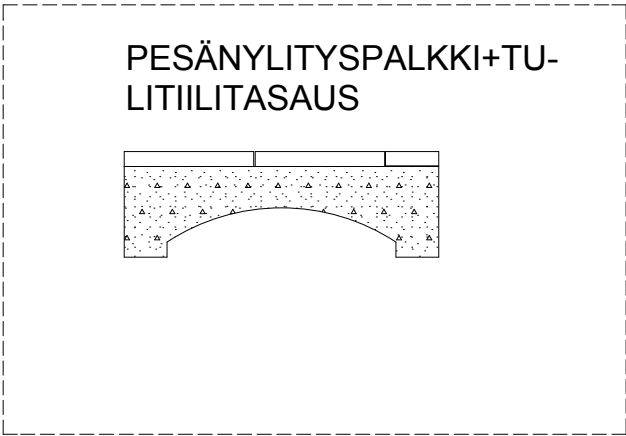

LEIVINUUNI 1100

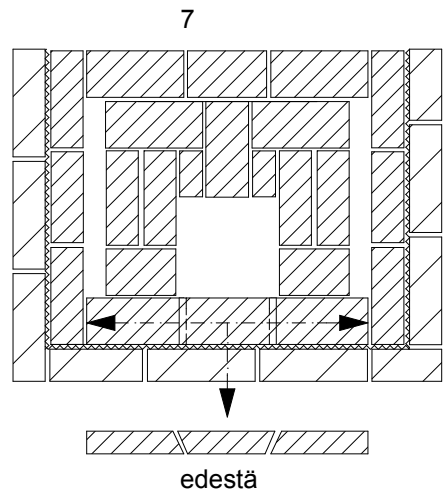
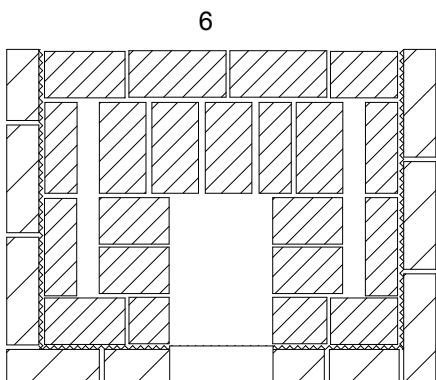
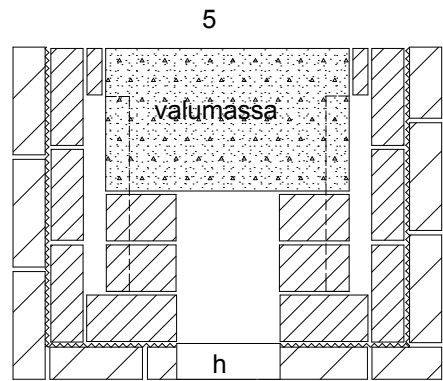
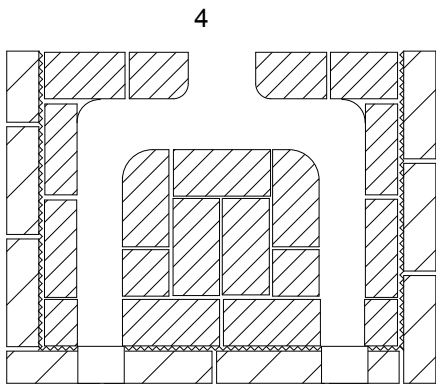
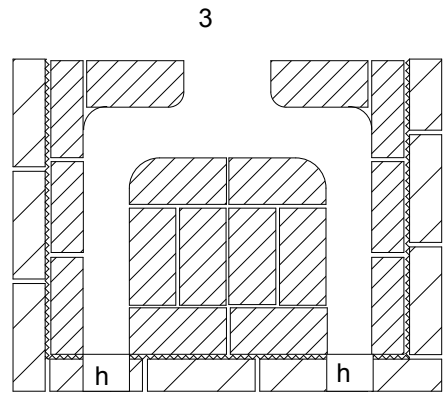
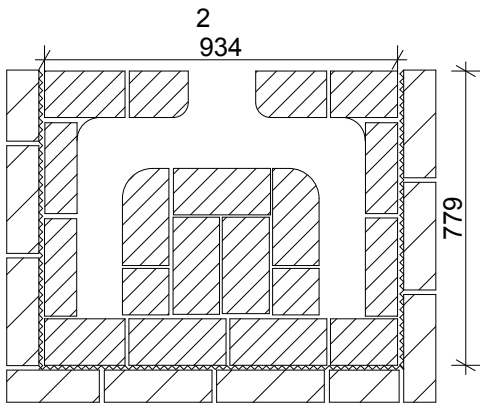
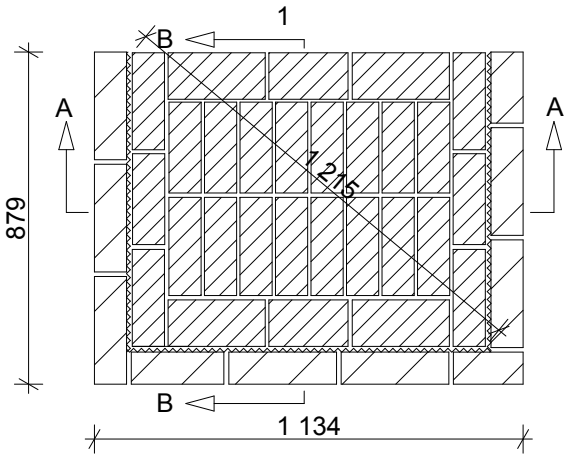

LEIVINUUNI 1100

8

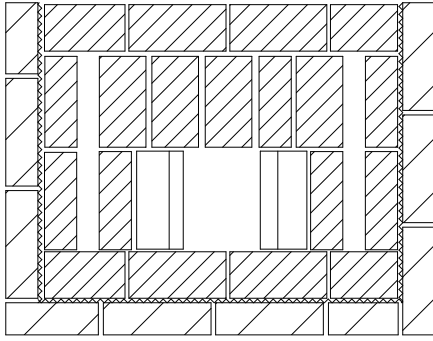

9

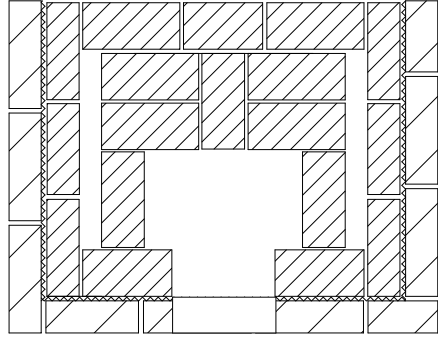

10

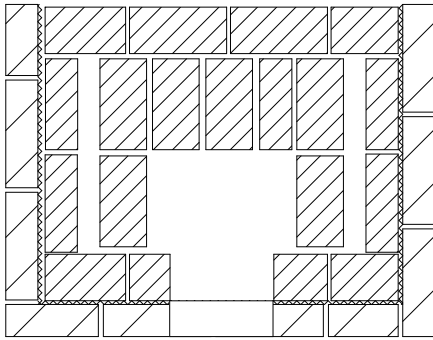

11

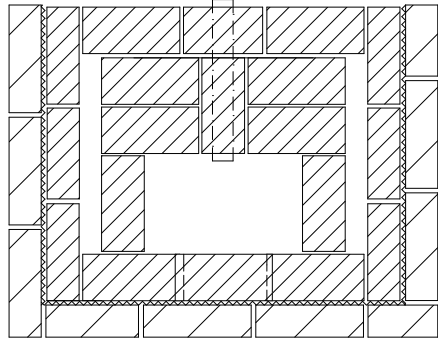

12

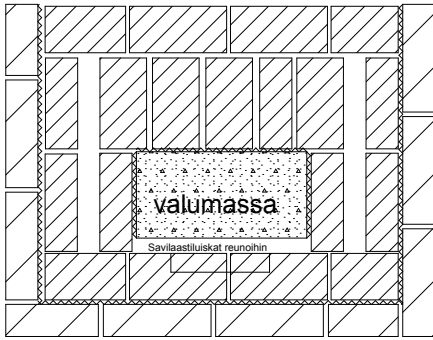

13

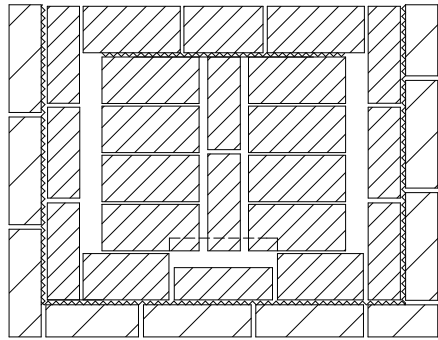

14

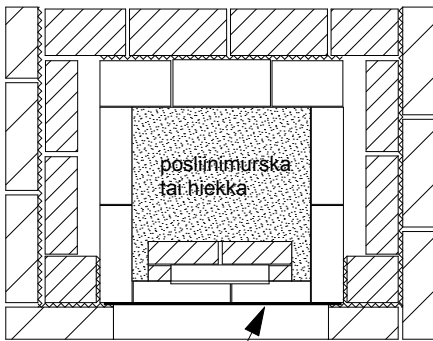

15

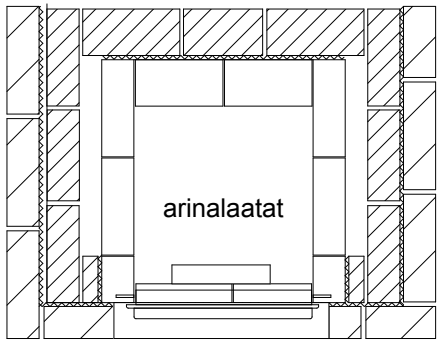

Uuninluukun taustalevy

LEIVINUUNI 1100

16

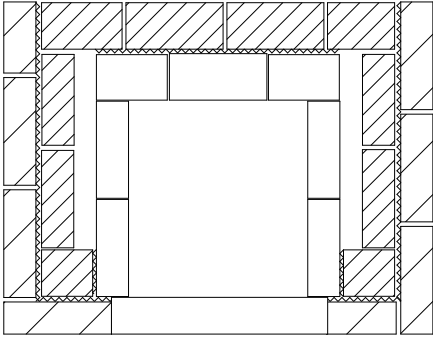

17

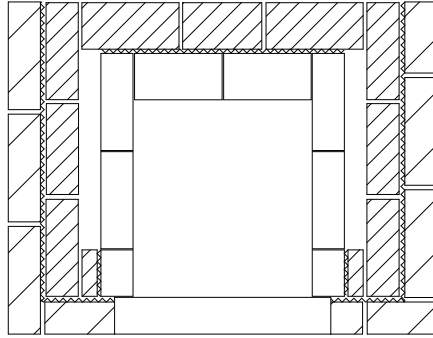

18

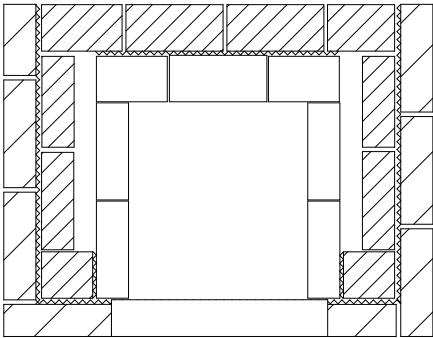

19

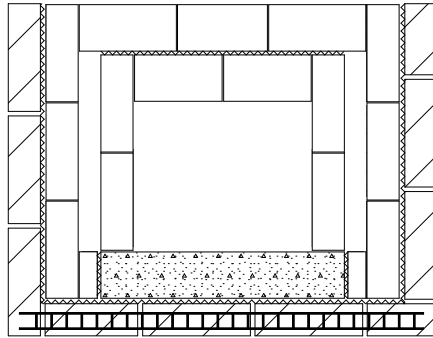

20

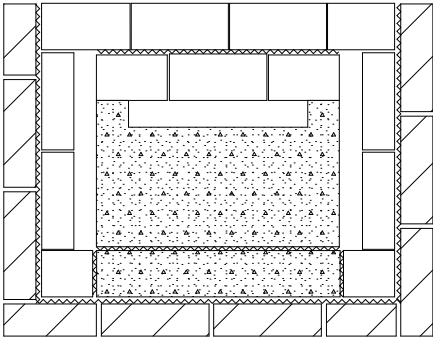

21

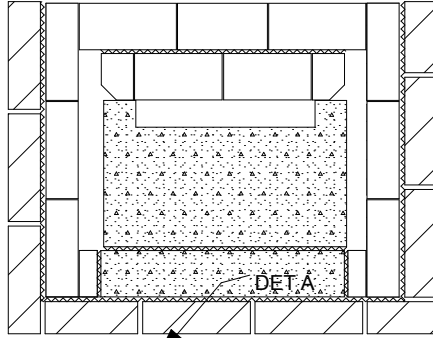

22

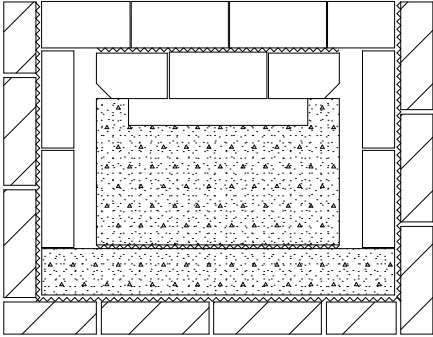

23

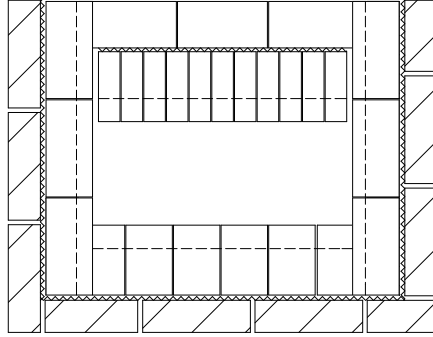

LEIVINUUNI 1100

24

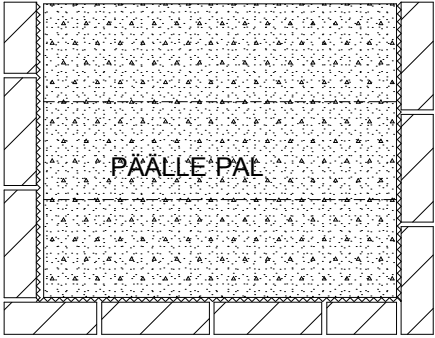

25

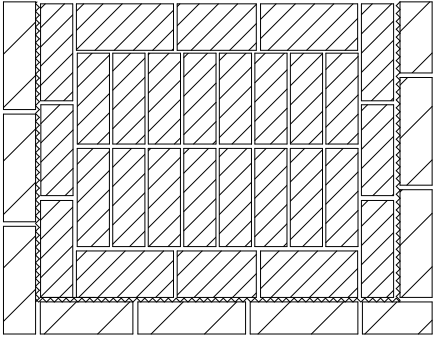

26

