

MATALA TAKKA 1260

Peruskokoinen PT tiili	~237kpl
MRT 60 kuorimuuraukseen	~230kpl
TTT tulitiili,257/123/57	~155 kpl
Saviuunilaasti	~237 kg
Tulenkestävä valumassa	~300 kg
M100/600, kuorimuurauslaasti	~207 kg
Tulenkestävä muurauslaasti ,tulitiilien muuraukseen	~38,75kg
TUL 10, tulisijalevy	~5,355m ²
PAL50, palonsuojalevy	1 levy
Takkaluukku 410/410	1
Tuhkapesän luukku 270/130, muurausholkkeineen	1
Nuohous 130/130, holkkeineen	2

MATALA TAKKA 1260

A-A

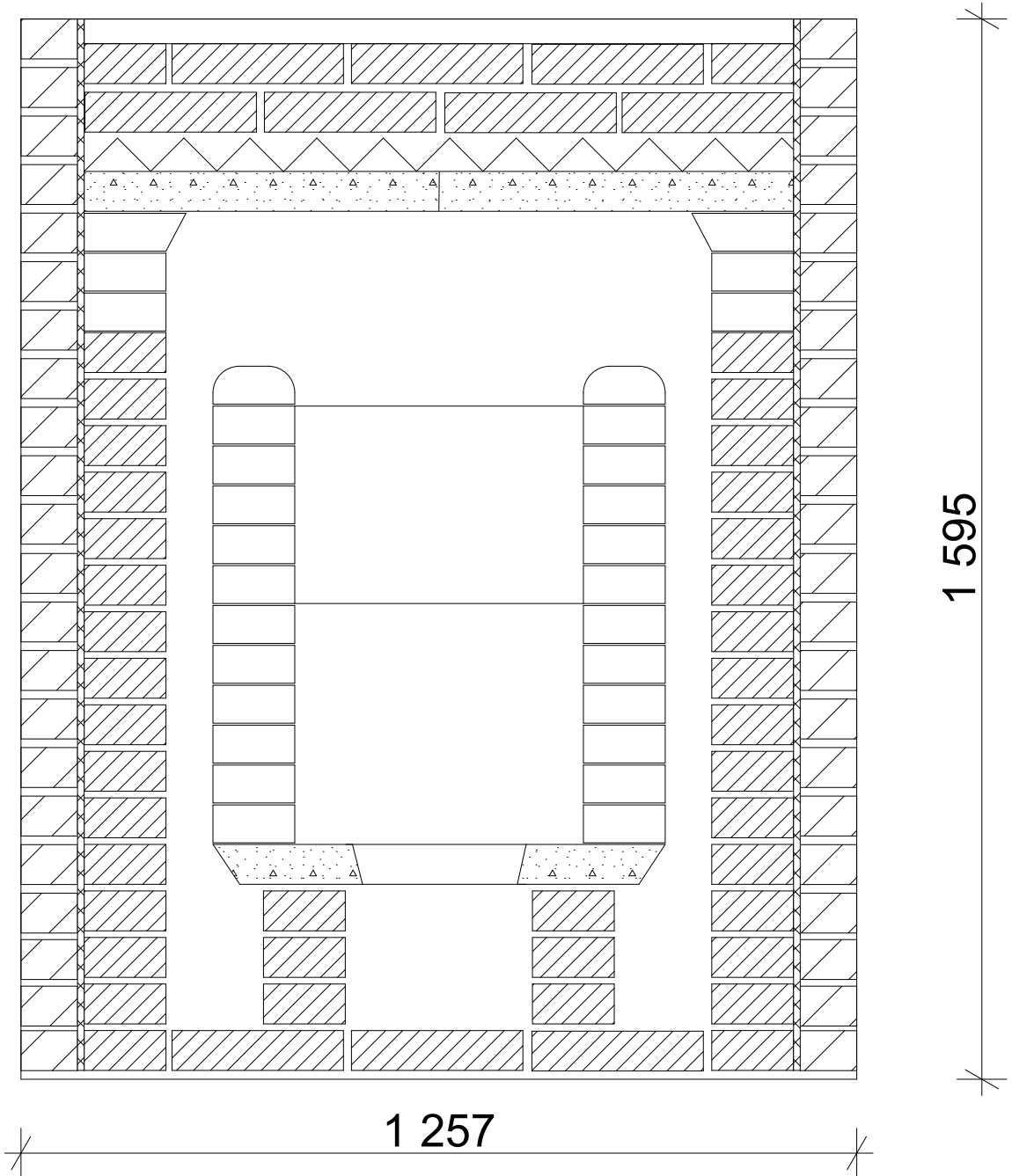

MATALA TAKKA 1260

B-B

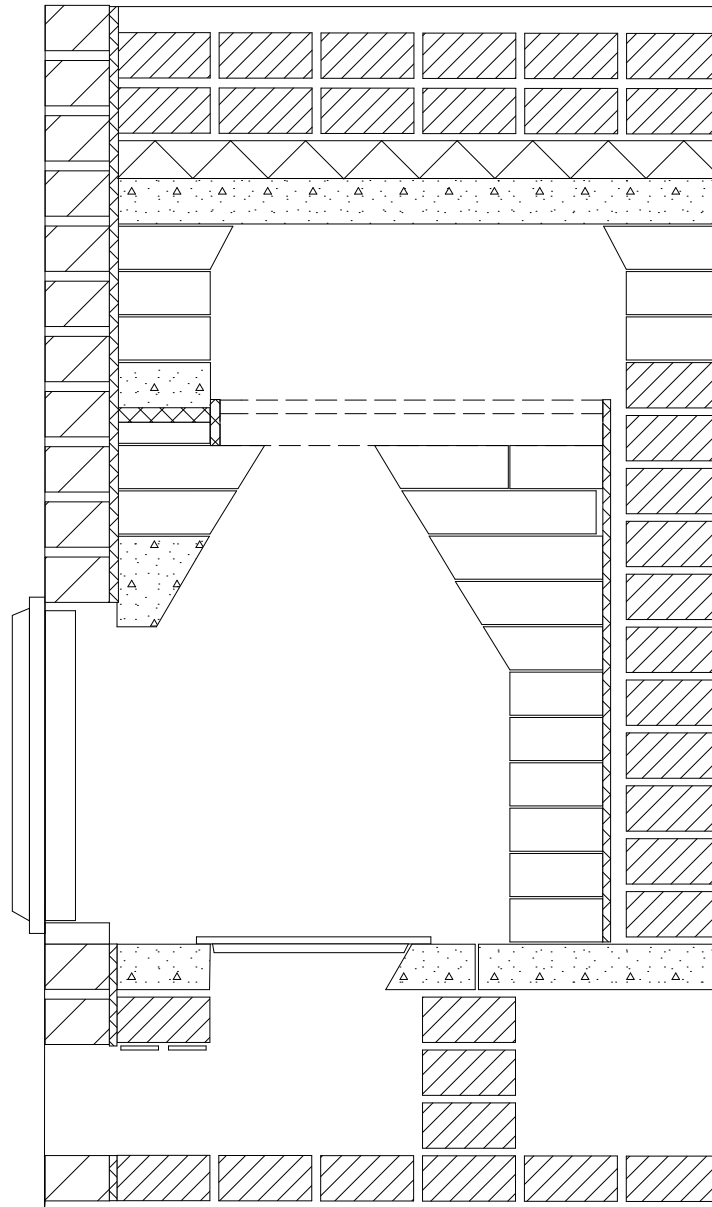

MATALA TAKKA 1260

Edestä

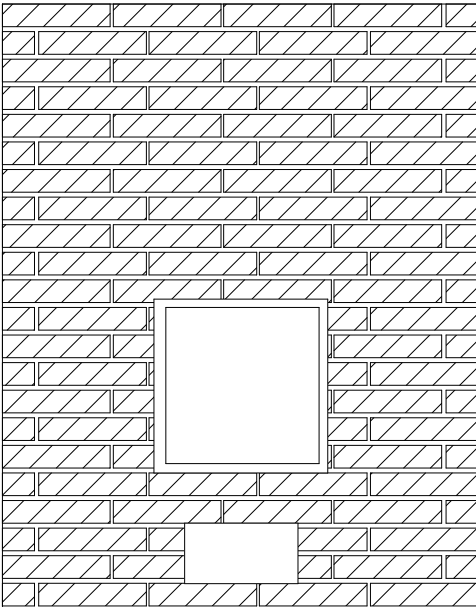

Oikealta sivulta

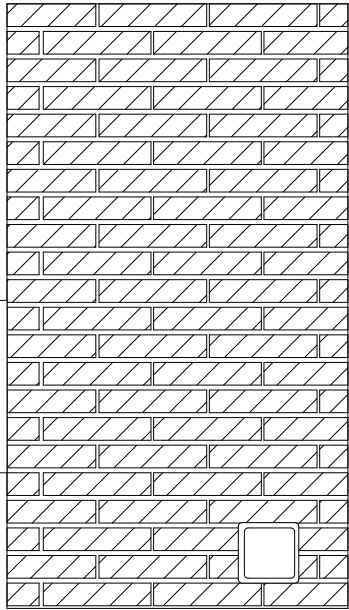

MATALA TAKKA 1260

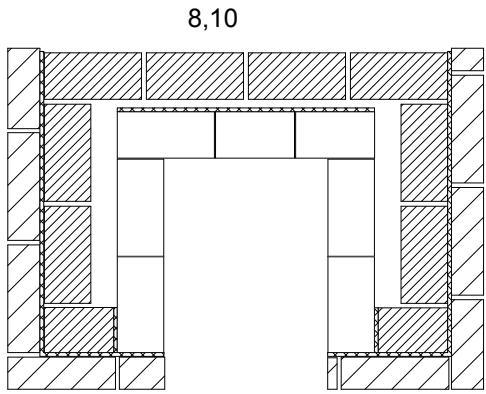
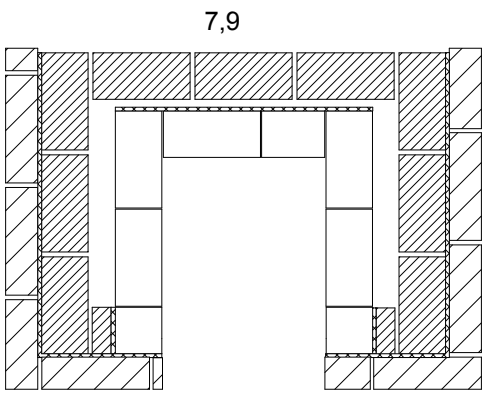
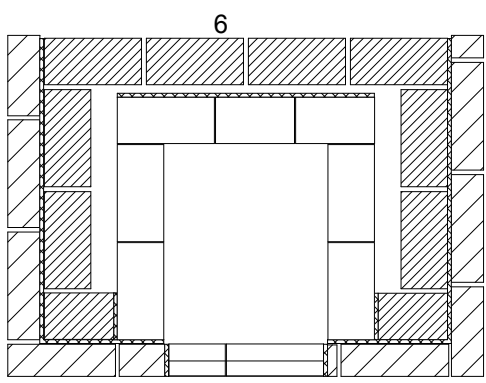
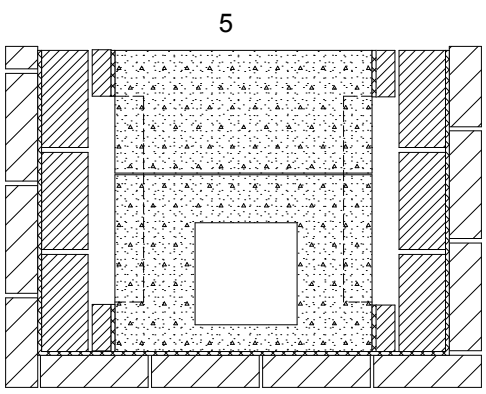
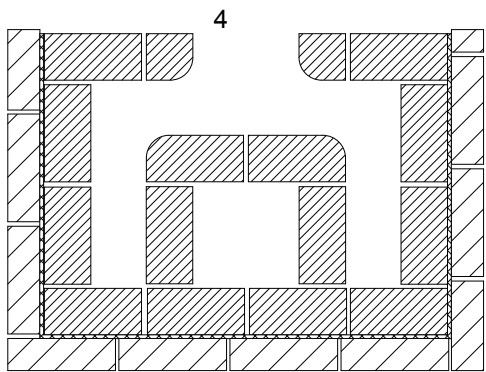
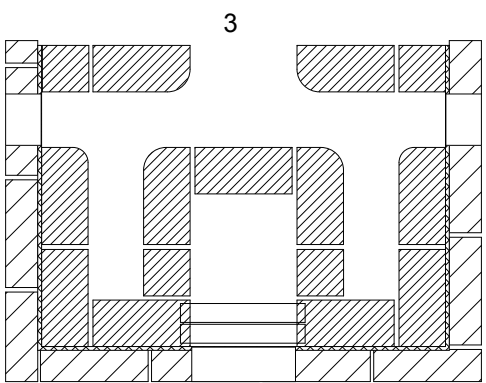
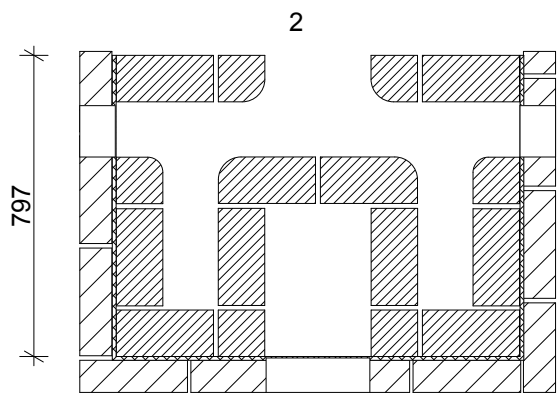
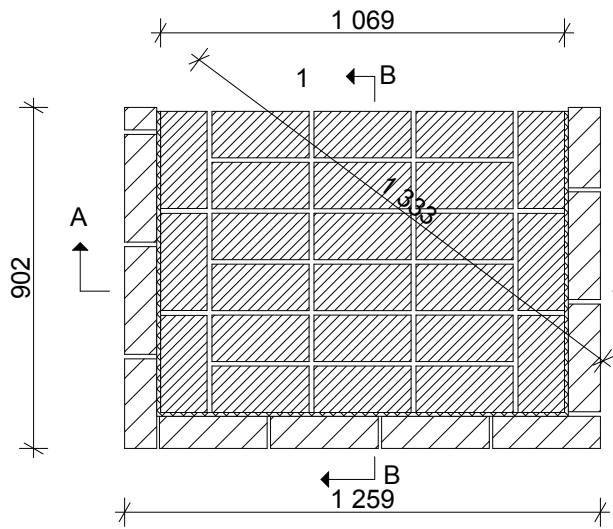

MATALA TAKKA 1260

10.5

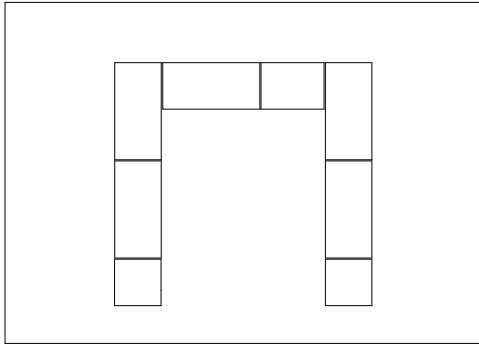

11

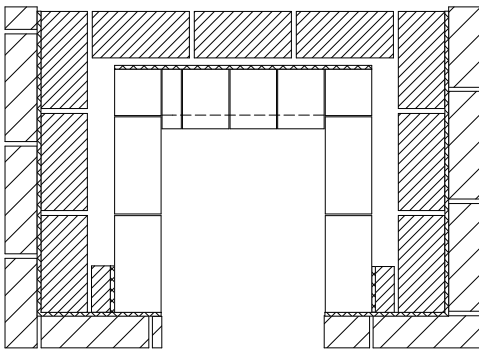

12

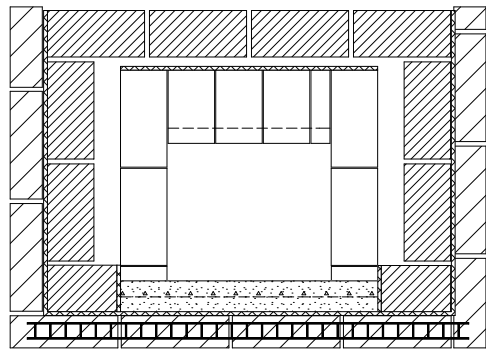

13

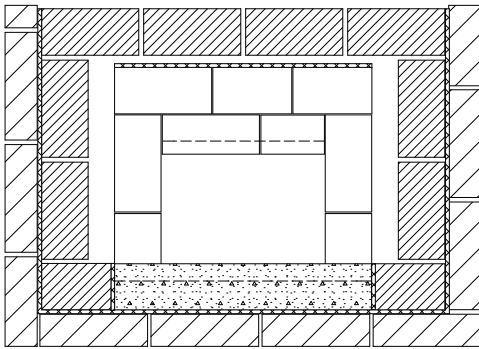

13,5

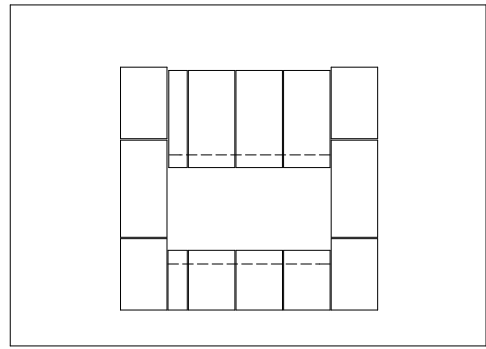

14

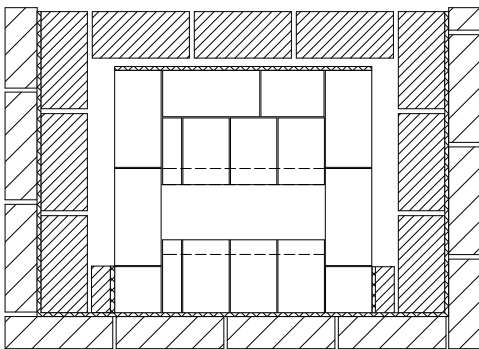

15

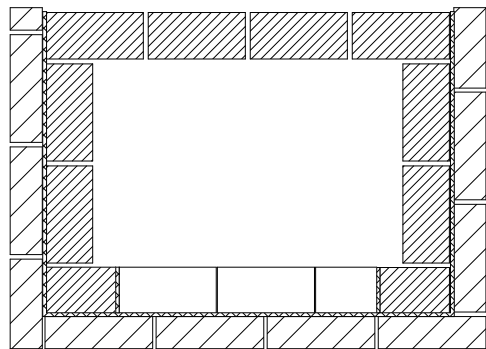

MATALA TAKKA 1260

16

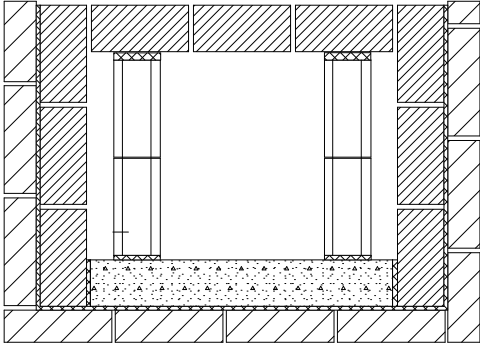

17

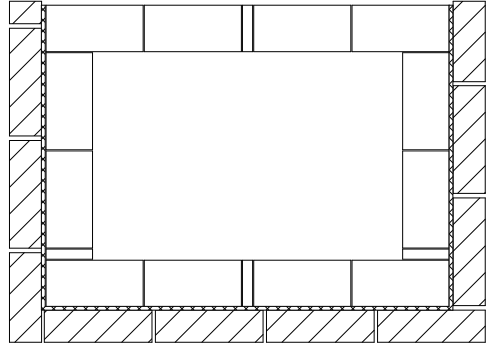

18

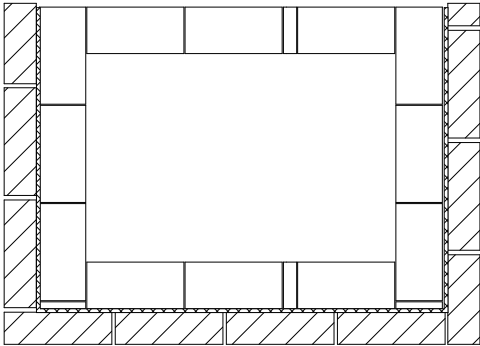

19

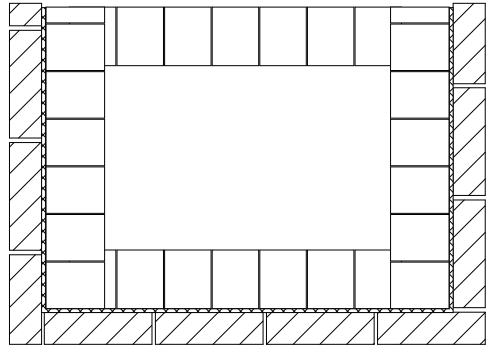

20

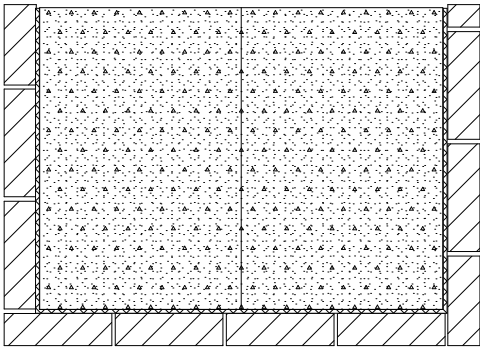

21

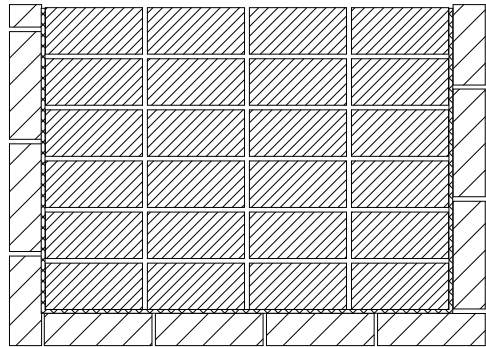

22

