

T1060 VARAAVA TAKKA

Peruskokoinen PT tiili	~143kpl
UT-tiili 257/85/57	~93kpl
MRT 60 kuorimuuraukseen	~238kpl
TTT tulitiili 257/123/57	~77 kpl
MTT tulitiili 257/85/57	~104kpl
Saviuunilaasti	~236 kg
Tulenkestävä valumassa	~175 kg
M100/600 muurauslaasti, kuoreen	~214 kg
Tulenkestävä muurauslaasti ,tulitiilien muuraukseen	~45kg
TUL 10, tulisijalevy	~5,306m ²
PAL50, palonsuojalevy	1 levy
Takkaluukku 410/410	1
Tuhkapesän luukku 270x130, muurausholkkeineen	1
Nuohousluukku 130x130	2

VARAAVA TAKKA 1060

A-A

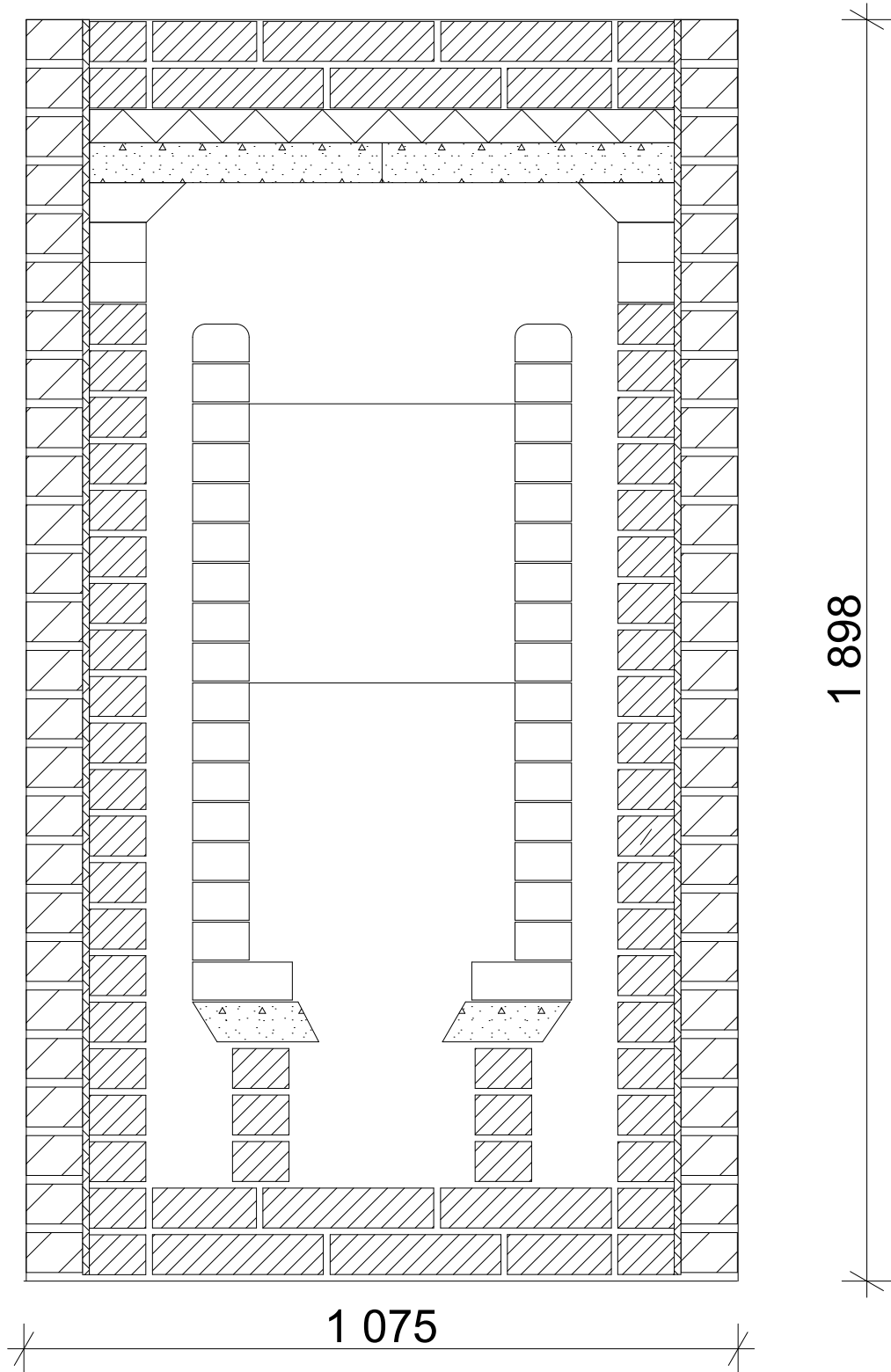

VARAAVA TAKKA 1060

B-B

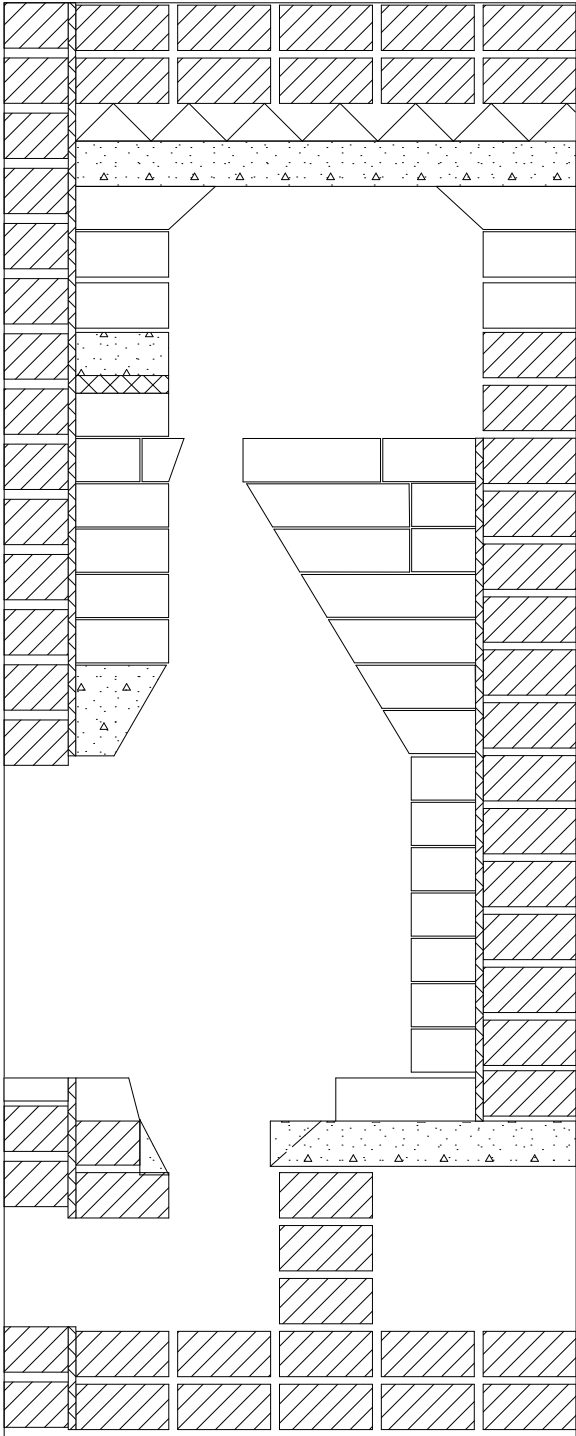

VARAAVA TAKKA 1060

EDESTÄ

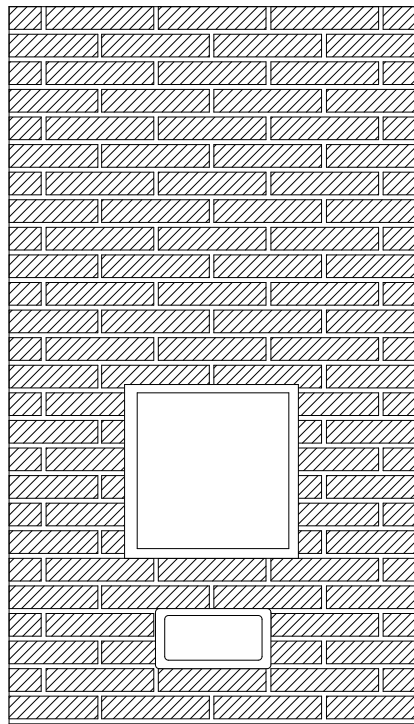

1 898

1 075

SIVULTA

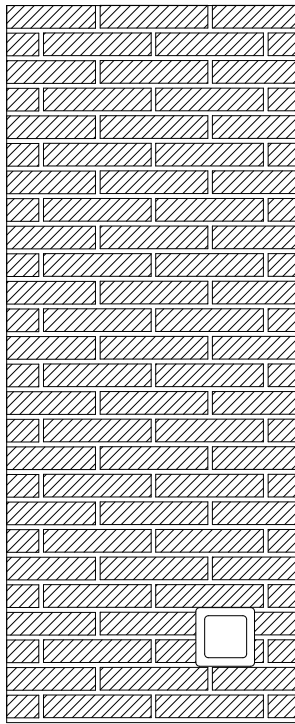

767

VARAAVA TAKKA 1060

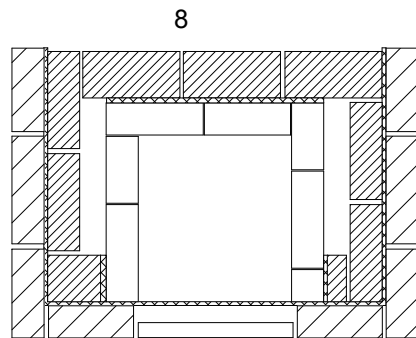
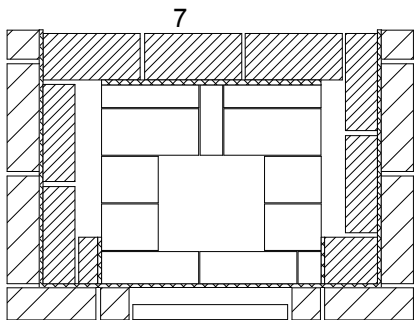
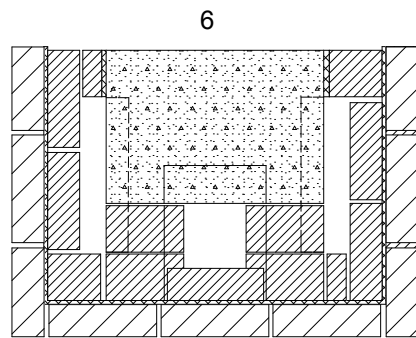
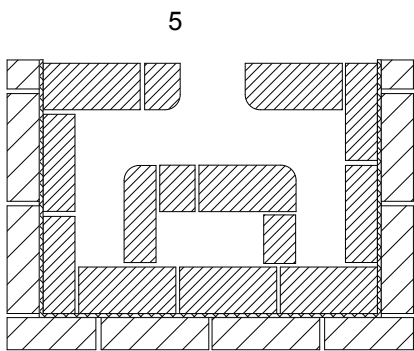
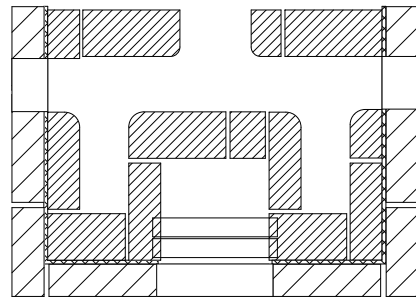
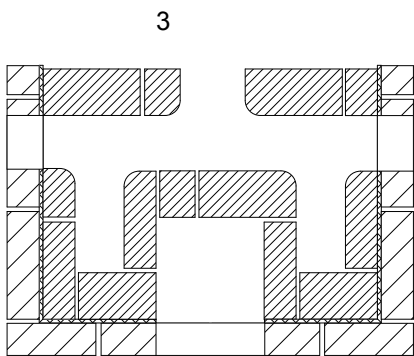
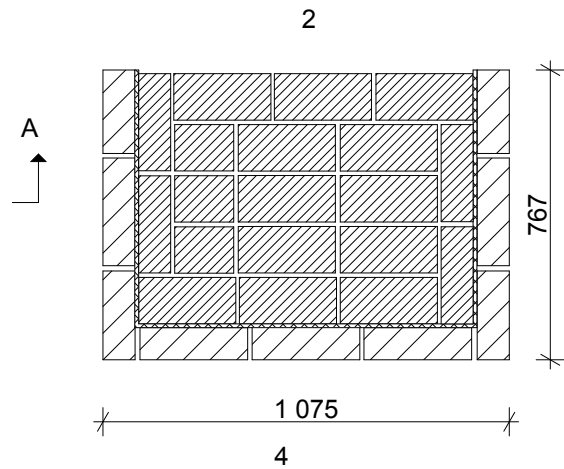
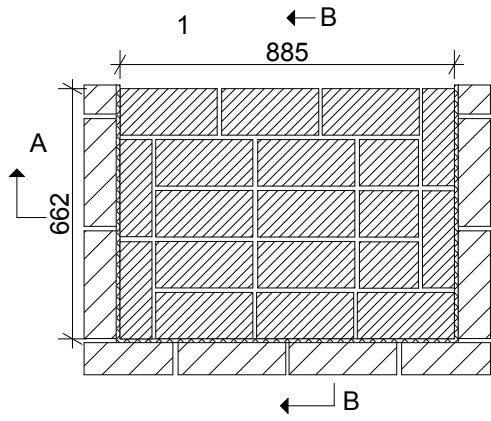

VARAAVA TAKKA 1060

9,11

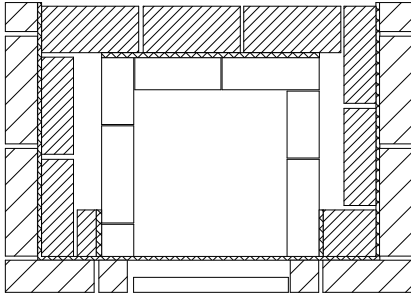

10,12

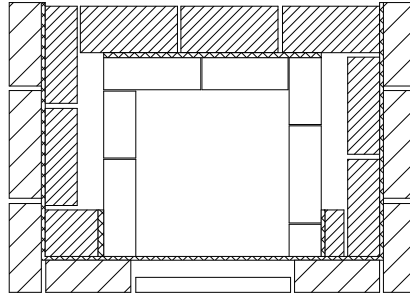

13

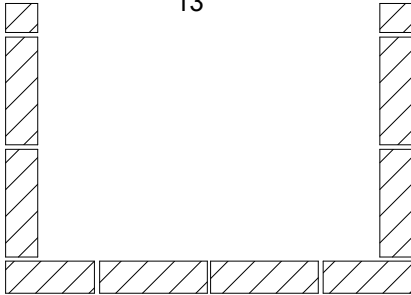

13,5

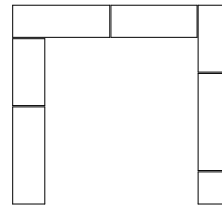

14

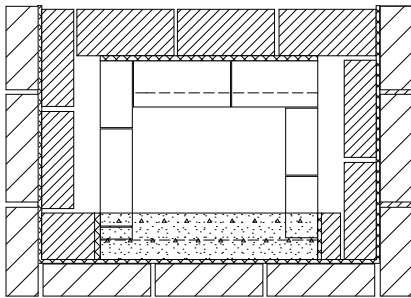

14.5

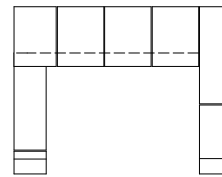

15

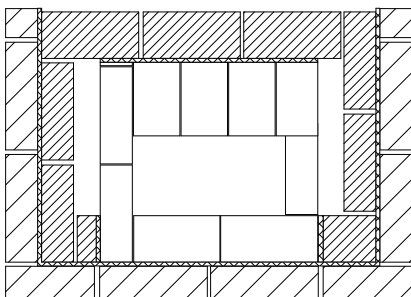

16

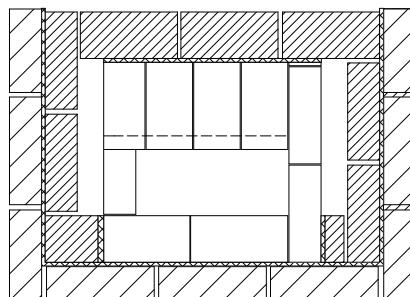

17

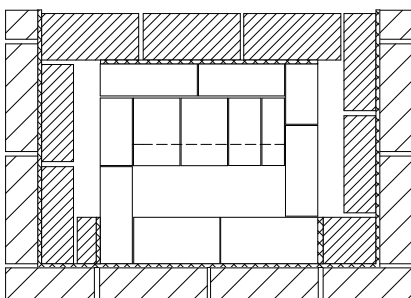

18

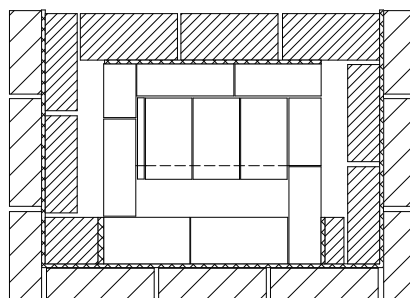

VARAAVA TAKKA 1060

19

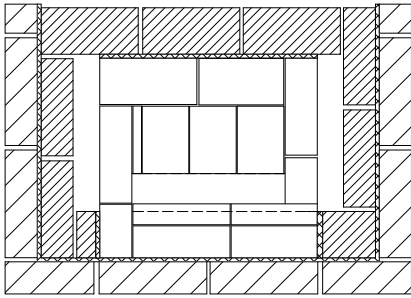

20

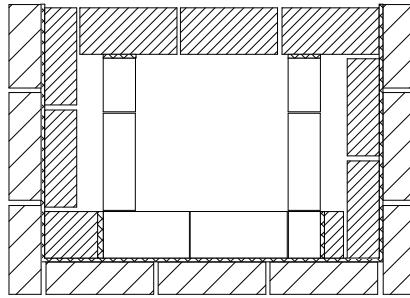

21

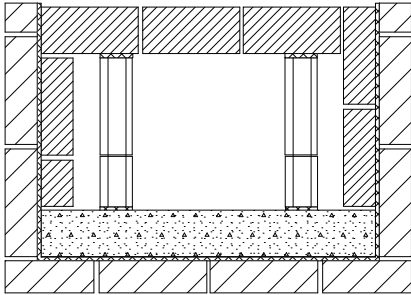

22

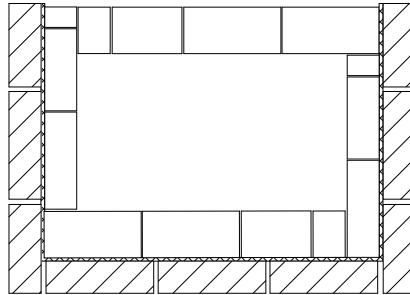

23

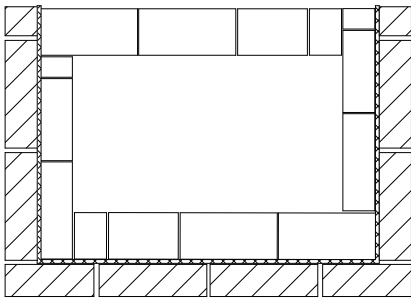

23.5

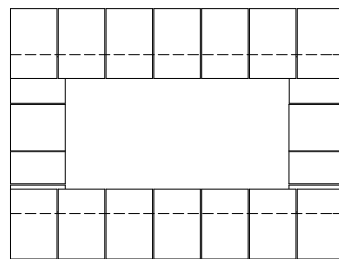

24

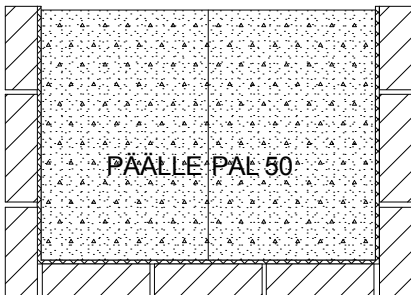

25

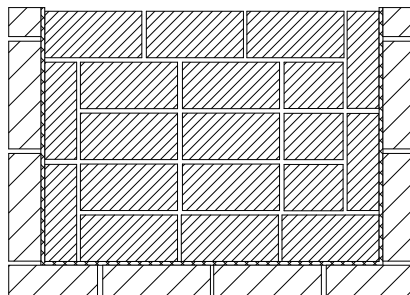

26

